

SECTION B-B

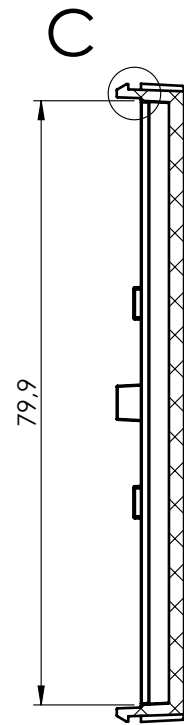

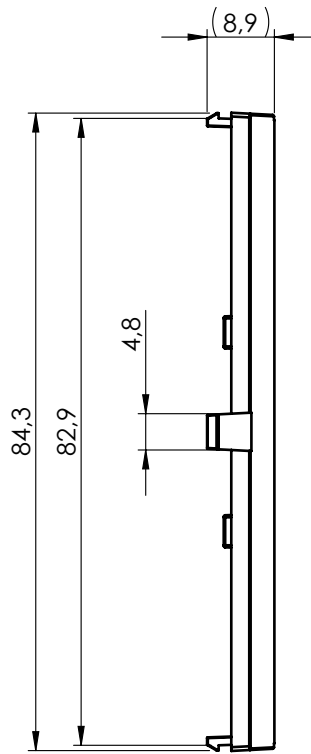

SECTION A-A

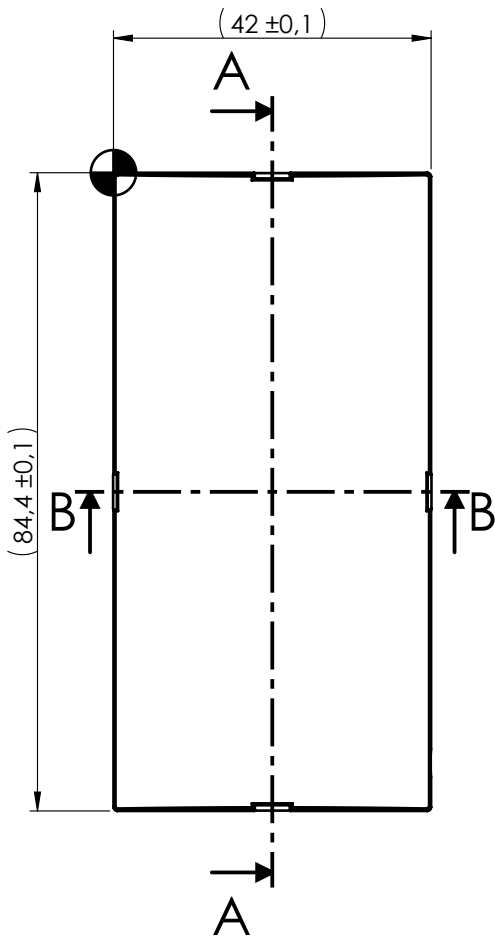
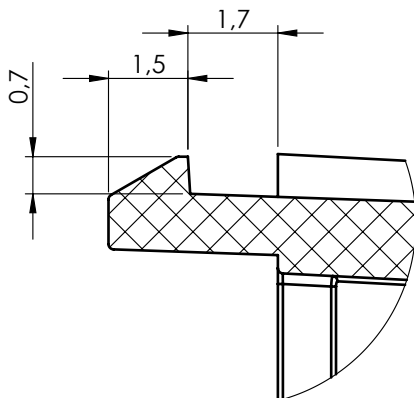

DETAIL C
SCALE 7 : 1

General information:

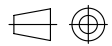
-  Workpiece zero point for mechanical processing
- Minimum recommended radius for machining = R1.0 mm

General Tolerance UNI EN 22768/1 Media (m)					Sheet:	
from 0.5 to 3 ± 0.1	from 3 to 6 ± 0.1	from 6 to 30 ± 0.2	from 30 to 120 ± 0.3	from 120 to 400 ± 0.5	1	
Scale: 1:1	Drawn:	Checked: R.N.	Date: 07/06/2023	Material: PC/ABS-PC	Process: INJECTION	
Dimension in mm		Derived from: --	Weight: 9.52 gr		Cod. Mold: ST.0525000	
		<small>The present drawing cannot be reproduced or communicated to 3rd parties, even partially, without the authorization of ITALTRONIC Srl. Italtronic reserves to protect its own rights according to the law.</small>		Description: PANNELLO CURVO MODULBOX 5M CURVED PANEL MODULBOX 5M		
 italtronic enclosures for electronics italtronic.com		Drawing nr.: 2_250_03716		Rev.: 00 A4		